

Wall Adjustable Brochure Rack, 6-12 Pockets

Product No. FLWM01120

ASSEMBLY & INSTALLATION INSTRUCTIONS

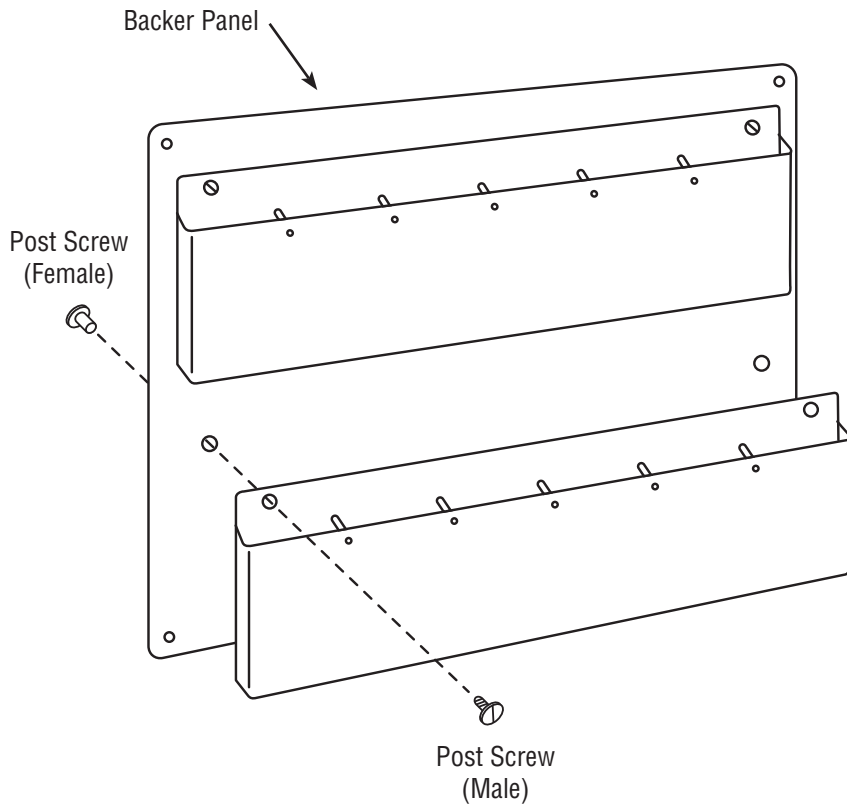

Mount the Literature Holders to the Backer

1. Place Literature Holder over the Backer matching up the screw holes.
2. Using the Post Screw sets, insert the male end through the Literature Holder and Backer (from the front) into the Female end.
3. Using a flat-head screw driver (not included), tighten the screw post.
4. Repeat for all location on the Literature Holders.

Mount to Wall:

5. Level rack on the wall to your liking.
6. Mount to the wall using the supplied Phillips head screws & anchors (best for sheet rock installations), or your own hardware.

* Clean unit with acrylic cleaner (or mild detergent & water) and soft cloth only. **DO NOT USE ALCOHOL!**

Parts & Hardware: *Prior to assembly, please be sure all of the parts and hardware are present. If you are missing any hardware, please call immediately.*

